

構成内容 / Components				
No.	名称 / Part name	数量 / Pcs	材質 / Material	色・表面処理 / Color・Finish
1	上下カバー Top and Bottom cover	各1 1 each	アクリル板 t3.0 Acrylic t3.0	透明 Transparent
2	Wパネル W panel	2	アクリル板 t3.0 Acrylic t3.0	透明 Transparent
3	Dパネル D panel	2	アクリル板 t3.0 Acrylic t3.0	透明 Transparent
4	支柱 Extruded pillar	4	アルミ押出材 A6063S-T5 Extruded aluminium A6063S-T5	シルバーアルマイト Silver・Anodized
5	取付ビス (六角穴付皿M4 x 10) Screw (Hexagonal M4 - 10)	8	ステンレス Stainless steel	無処理 Unfinished
6	ゴム足 / Rubber feet	0 or 5	ポリウレタン / Polyurethane	透明 / Transparent

■六角レンチ付です。  
Hexagonal wrench included.

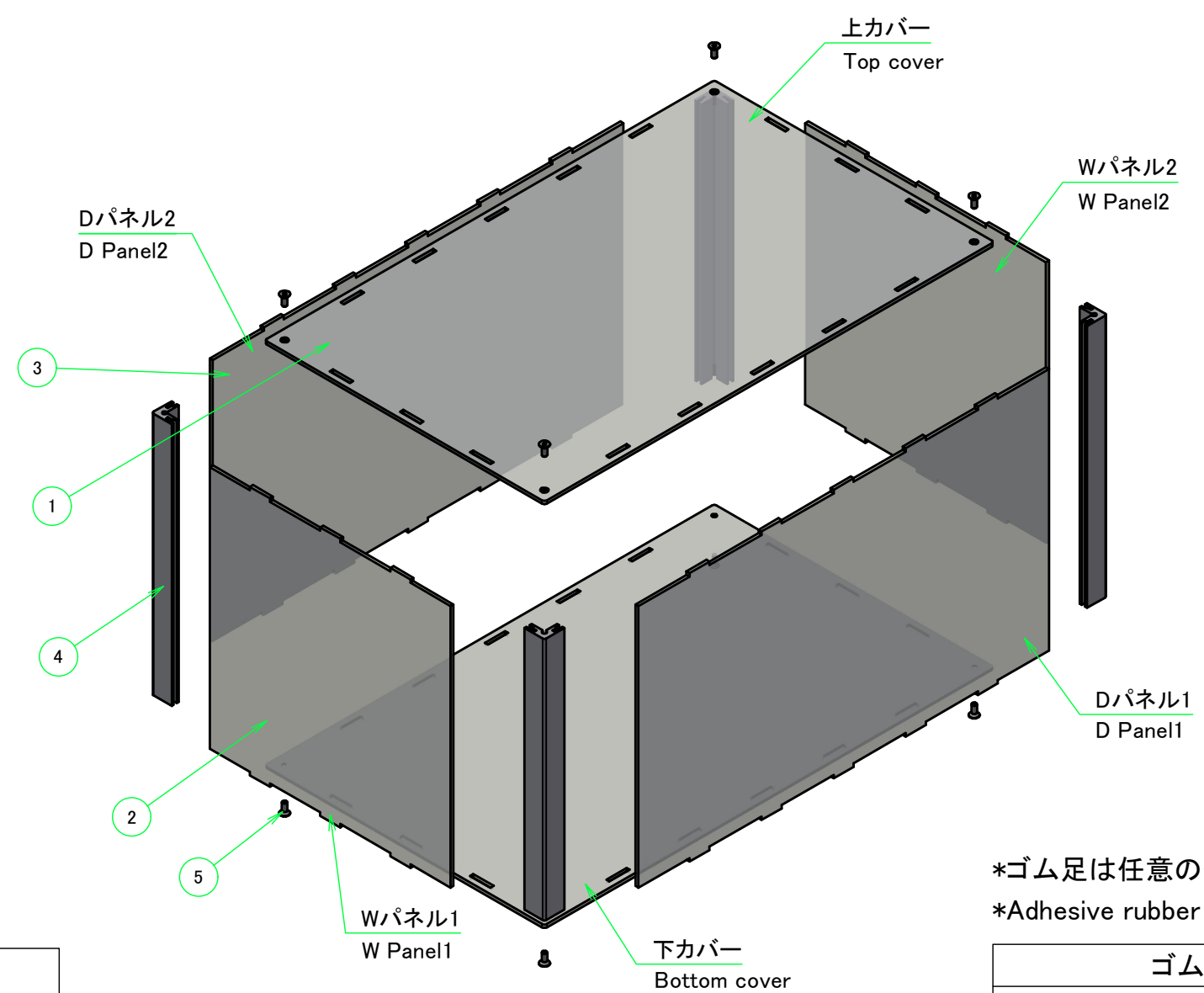

\*ゴム足は任意の位置に貼り付けできます。  
\*Adhesive rubber feet in cluded

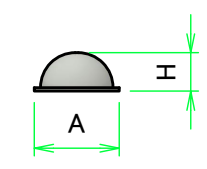

ゴム足 / Rubber feet		
記号 / Code	A	H
N (無し) / None	-	-
S	11.2	5.1
L	15.7	7.9

ケース型番 / Product Number

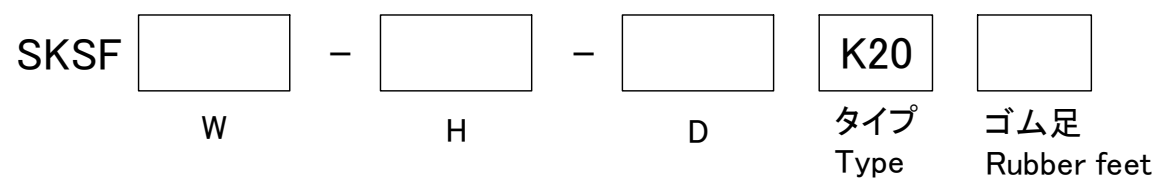

W・H・D 寸法制限範囲 / Dimension limit range		
W	H	D
301 ~ 400	30 ~ 500	151 ~ 200

株式会社タカチ電機工業 TAKACHI ELECTRONICS ENCLOSURE CO., LTD.			品名/Title 角型スケルトンフリーサイズケース CUSTOM SIZED ACRYLIC CASE	尺度/Scale 1 / 5
承認/Approved 中根	検図/Checked 常山	製図/Created 野村	型番/Product number SKSF□-□-□K20□ (W301~400, D151~200) 作成日/Date 2020/12/11	

# 外視 / External View

Wパネル2 / W Panel 2

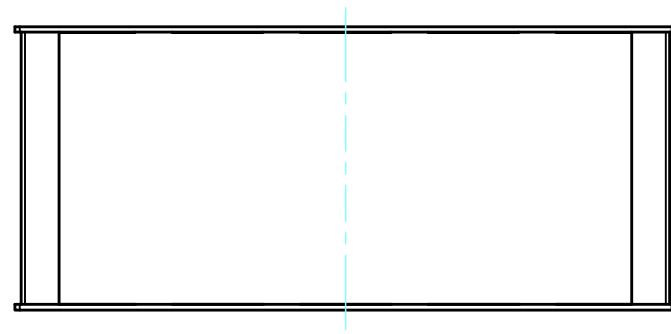

Dパネル2 / D Panel 2

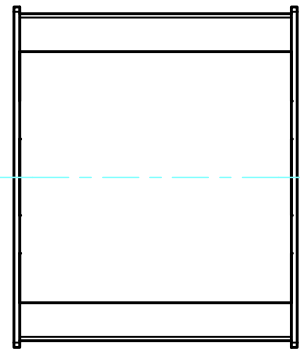

上カバー / Top cover

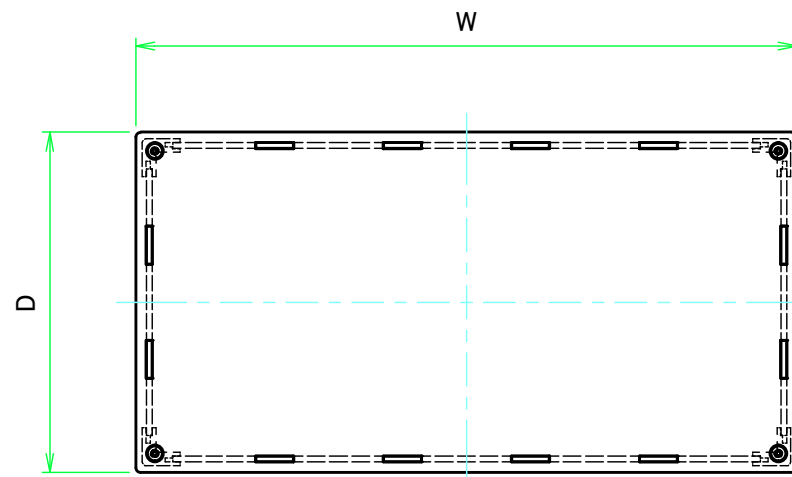

Dパネル1 / D Panel 1

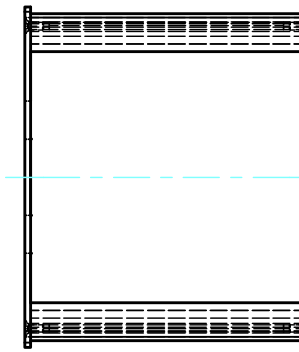

下カバー / Bottom cover

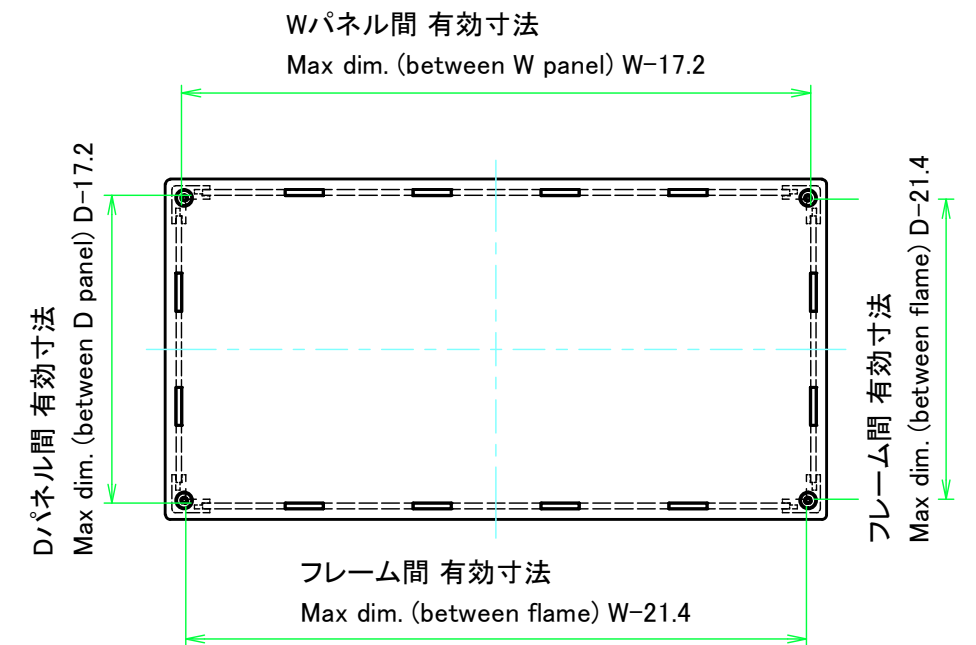

Wパネル1 / W Panel 1

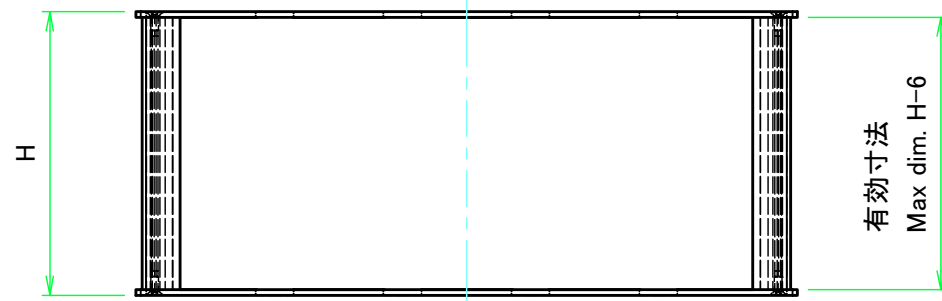

<b>株式会社タカチ電機工業</b> <small>TAKACHI ELECTRONICS ENCLOSURE CO., LTD.</small>			品名/Title 角型スケルトンフリーサイズケース CUSTOM SIZED ACRYLIC CASE	尺度/Scale 1:4
承認/Approved	検図/Checked	製図/Created	型番/Product number SKSF□-□-□K20□ (W301~400, D151~200)	
中根	常山	野村	作成日/Date 2020/12/11	2 / 5

上下カバー / Top and Bottom cover

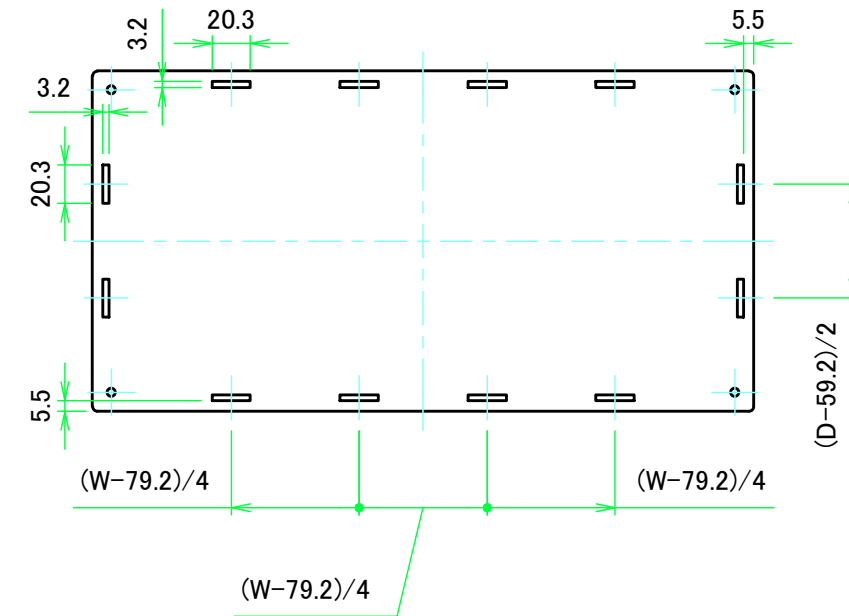
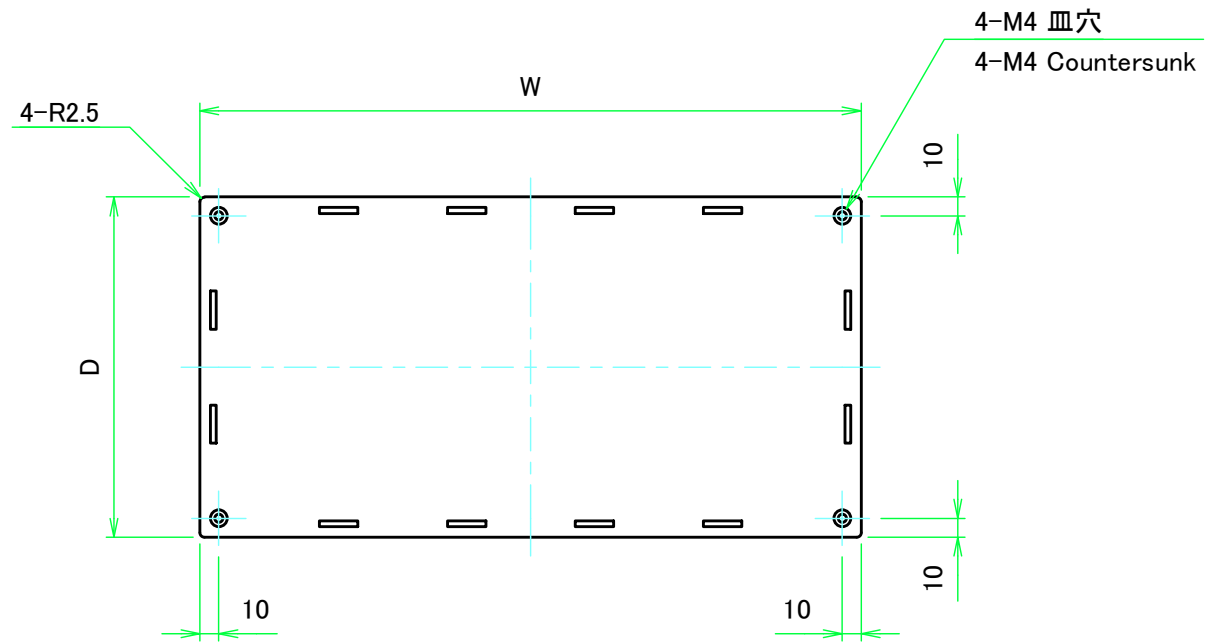

上カバー表面 / Top cover Frontside

上カバー裏面 / Top cover Backside

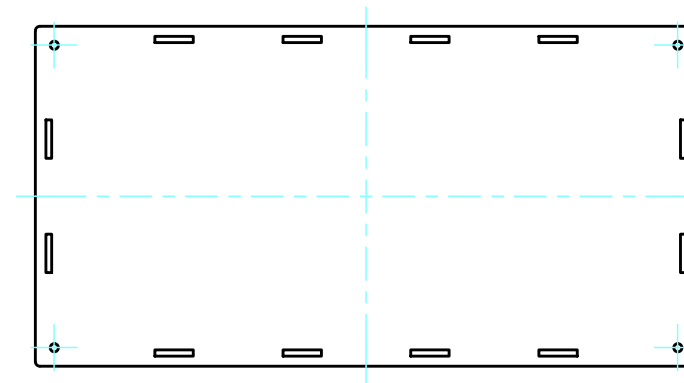
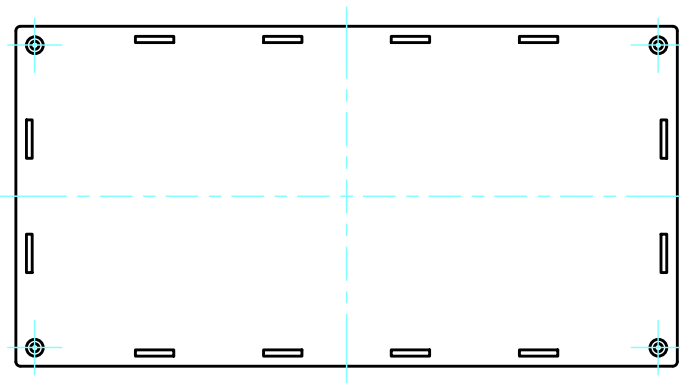

下カバー表面 / Bottom cover Frontside

下カバー裏面 / Bottom cover Backside

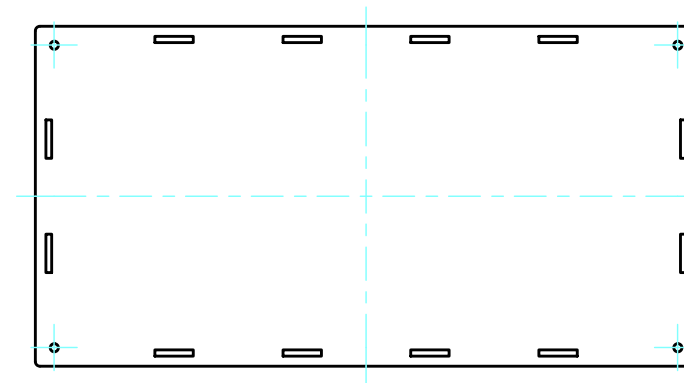
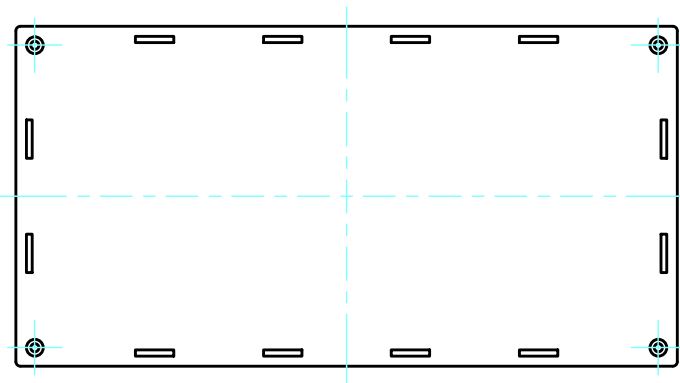

<b>株式会社タカチ電機工業</b> <small>TAKACHI ELECTRONICS ENCLOSURE CO., LTD.</small>			品名/Title 角型スケルトンフリーサイズケース CUSTOM SIZED ACRYLIC CASE	尺度/Scale 1:4
承認/Approved	検図/Checked	製図/Created	型番/Product number SKSF□-□-□K20□ (W301~400, D151~200)	
中根	常山	野村	作成日/Date 2020/12/11	3 / 5

Wパネル / W Panel

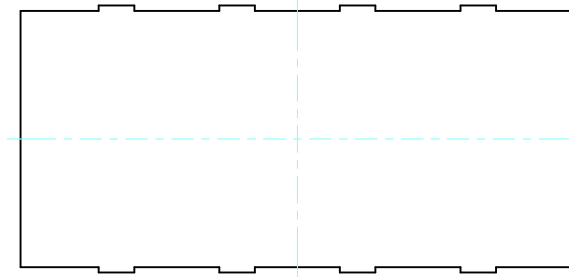
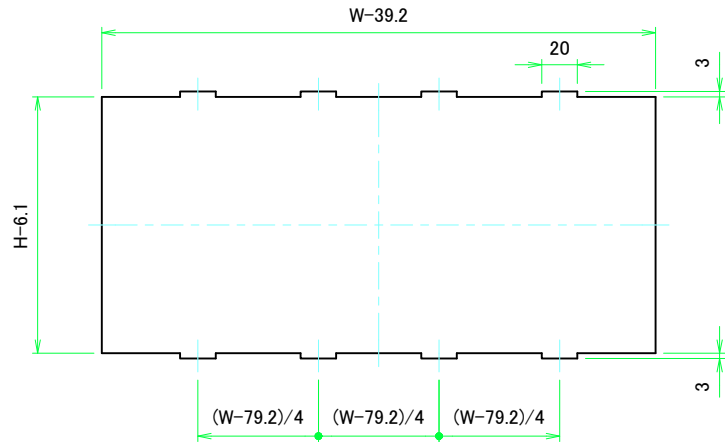

Wパネル1表面 / W Panel 1 Frontside

Wパネル1裏面 / W Panel 1 Backside

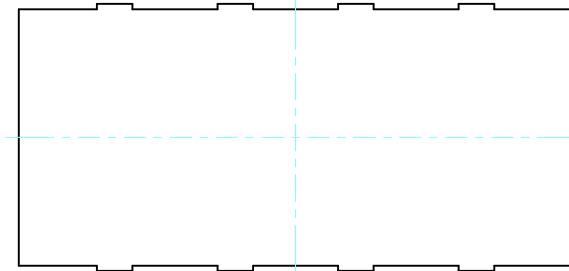
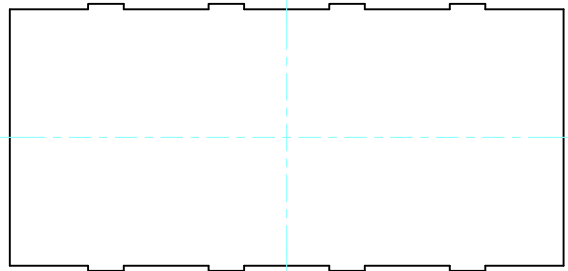

Wパネル2表面 / W Panel 2 Frontside

Wパネル2裏面 / W Panel 2 Backside

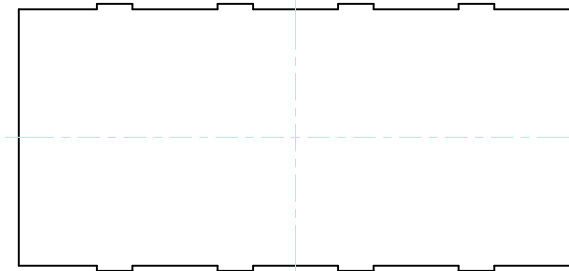
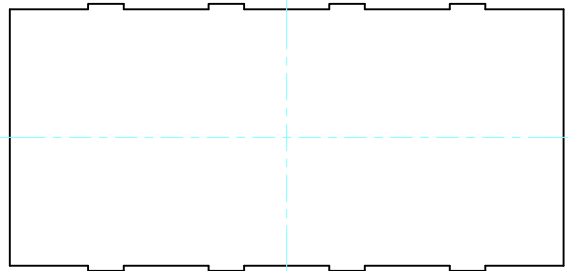

株式会社タカチ電機工業 TAKACHI ELECTRONICS ENCLOSURE CO., LTD.			品名/Title 角型スケルトンフリーサイズケース CUSTOM SIZED ACRYLIC CASE	尺度/Scale 1:3
承認/Approved 中根	検図/Checked 常山	製図/Created 野村	型番/Product number SKSF□-□-□K20□ (W301~400, D151~200)	
			作成日/Date 2020/12/11	4 / 5

# Dパネル / D Panel

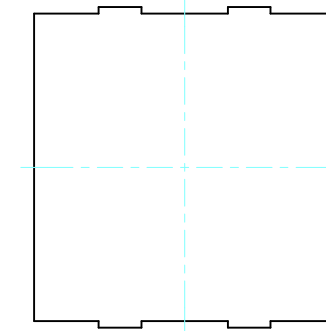
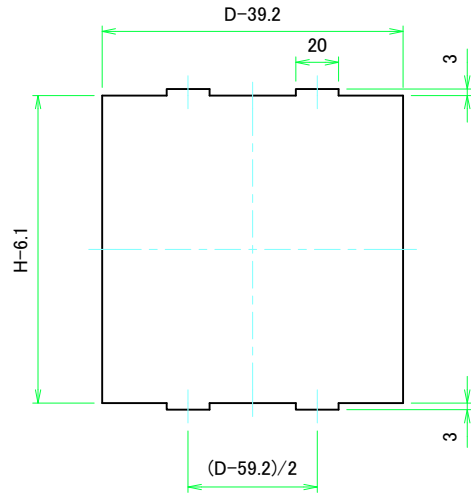

Dパネル1表面 / D Panel 1 Frontside

Dパネル1裏面 / D Panel 1 Backside

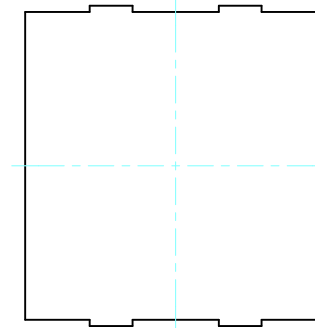
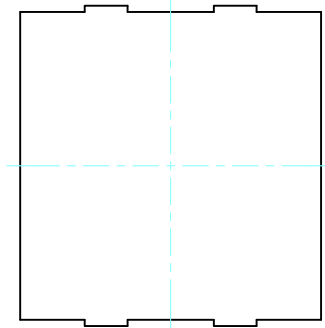

Dパネル2表面 / D Panel 2 Frontside

Dパネル2裏面 / D Panel 2 Backside

<b>株式会社タカチ電機工業</b> <small>TAKACHI ELECTRONICS ENCLOSURE CO., LTD.</small>			<b>品名/Title</b> 角型スケルトンフリーサイズケース <small>CUSTOM SIZED ACRYLIC CASE</small>	<b>尺度/Scale</b> 1:2.5
<b>承認/Approved</b> 中根	<b>検図/Checked</b> 常山	<b>製図/Created</b> 野村	<b>型番/Product number</b> SKSF□-□-□K20□ (W301~400, D151~200)	
			<b>作成日/Date</b> 2020/12/11	5 / 5